



NH3 / LIQUID FERTILIZER PLANT EQUIPMENT

FREE FREIGHT

On Orders \$2500 Or Over

Exclusions Apply. (See Back Cover)

Special Prices Good Thru 9/13/24

VISIT DULTMEIER.COM FOR NEW ITEMS AND MORE SPECIALS!

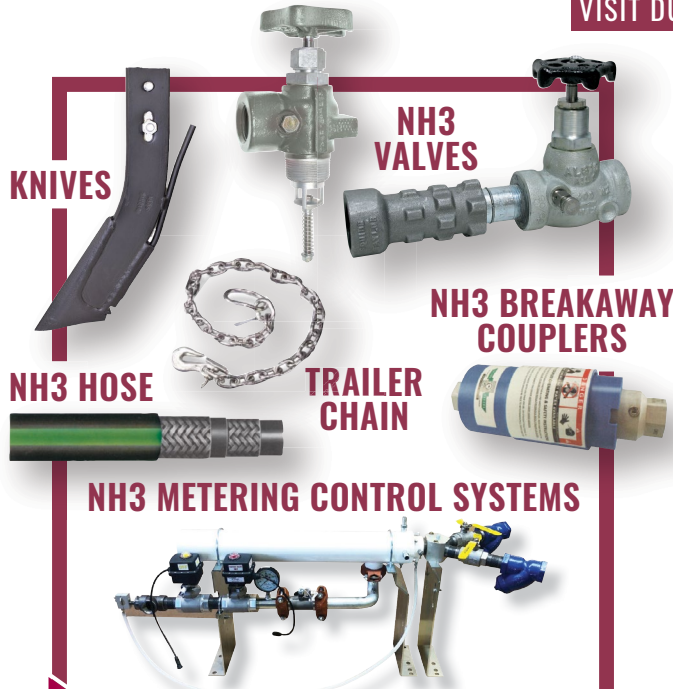

KNIVES

NH3 VALVES

NH3 BREAKAWAY COUPLERS

NH3 HOSE

TRAILER CHAIN

NH3 METERING CONTROL SYSTEMS

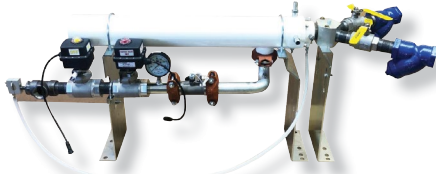

2-9

NH3 PLANT & APPLICATION EQUIPMENT



10-13

LIQUID FERTILIZER PLANT EQUIPMENT & AUTOMATION

PLANT AUTOMATION



13

PLANT AUTOMATION



14

TANKS



15-16

DEF & FUEL TANKS, PUMPS, NOZZLES & HOSE



SUMMER 2024 NH3/EQUIPMENT SPECIALS

VISIT DULTMEIER.COM FOR NEW ITEMS AND MORE SPECIALS! GOOD THRU 9/13/24

Overhead Valve Engines

HONDA
ENGINES

Recoil & Electric Starters
HORIZONTAL-SHAFT

TX Series - Ideal for use as a Replacement Pump Engine

OHV Style. All Honda standard features plus transistorized ignition system, dual oil fillers, rewind starters, bottom intake air cleaner and oil alert feature.

GX390 11.7-HP SERIES (389cc)

The largest of Honda's single cylinder industrial engines. All standard Honda features plus CDI ignition with electronic advance, oil alert feature and automatic decompression release. Fuel tanks are 7.4 Qt.

Crankshaft: 1" diameter tapped 3/8-24 UNF with keyway.

GX390K1QA Standard Model: With rewind starter.



GX390

HONDA
ENGINES

4.8-HP GX160 Series (163cc)

GX160K1QXE: Same as GX160K1QX except with electric start.

GX160K1TX: Pump Engine has a 5/8"-18 threaded shaft and mounting flange for use with close-coupled Centrifugal pumps.

5.5-HP GX200 Series (196cc)

GX200QX2: Has a 3/4" O.D. Keyed shaft, drilled & tapped 5/16"-24.



CRX208CC

CRX208CC: 5.7HP / 208cc • Single Cylinder • 3/4" solid shaft • Dual element air cleaner • Low oil shutdown • .7 gallon fuel tank capacity • Recoil start.

CRX420CC: 12.1HP / 420cc • Single Cylinder • 1" solid shaft • Dual element air cleaner • Low oil shutdown • 1.6 gallon fuel tank capacity • Recoil start or 12-volt start with 18 amp alternator.



Part No.	Make	** Starter	Shaft	SPECIAL
AE GX160K1QXE	Honda, 4.8 HP	12-Volt	3/4" Solid	\$ 580.00
AE GX160K1QX	Honda, 4.8 HP	Recoil	3/4" Keyed	333.00
AE GX160K1TX	Honda, 4.8 HP	Recoil	* 5/8" Threaded	340.00
AE GX200QX2	Honda, 5.5 HP	Recoil	3/4" Solid	354.00
AE GX390K1QA	Honda, 11.7 HP	Recoil	1" Solid	598.00
FN CRX208CC	CRX, 5.7 HP	Recoil	3/4"	229.00
FN CRX420CC	CRX, 12 HP	Recoil	1"	416.00
FN CRX420CC/E	CRX, 12 HP	12-Volt	1"	513.00
HY 2541-0066	Briggs, 6.5 HP	Recoil	3/4" Solid	236.00

* Threaded shaft for centrifugal pumps.

** 12-Volt Starters are Standard with 9 Amp Alternators.

Klinger's Nurse Tank Paint

Klinger is a family owned paint manufacturer out of Cedar Rapids, Iowa. The Klinger name is synonymous with quality and long-lasting products. As of 2018 Dultmeier Sales is now partnering with Klinger to expand our product offerings and allow you to consolidate your purchasing power. These products are sold in either 1 gallon or 5 gallon options. All Klinger products are drop shipped directly from Klinger's facility in Cedar Rapids, Iowa.



Part No.	Description	SPECIAL
KL 62017-1	White Silicon Paint, 1 Gallon	\$ 63.50
KL 62017-5	White Silicon Paint, 5 Gallon	292.00
KL 11017-1	Bright White Tank Paint, 1 Gallon	46.30
KL 11017-1MR	Bright White Tank Paint Mildew Resistant, 1 Gallon	46.10
KL 11017-5MR	Bright White Tank Paint Mildew Resistant, 5 Gallon	236.00
KL 11017-5	Bright White Tank Paint, 5 Gallon	228.00
KL 14022-1	Epoxy Primer, 1 Gallon	59.70
KL 14022-5	Epoxy Primer, 5 Gallon	296.00

Heat Treated Hitchpins



These hitch pins have a red plastisol coated head and are made from high-tensile steel. Hairpin clip included. Made in the U.S.A.

Part No.	Diameter	Usable Length	Std. Pkg.	Std. Pkg. Discount	SPECIAL
OH H34-4	3/4"	4"	12	20%	\$ 8.10
OH H34	3/4"	6-1/2"	12	20%	8.50
OH H78	7/8"	6-1/2"	12	20%	10.70
OH H100	1"	7-1/2"	6	20%	14.60

Ag Trailer Chains



Trailer Safety Chains designed to meet the requirements of ANSI/SAE Standard S338.5. All chains come with latch-style grab hooks that will not separate from the towing vehicle. A permanent ID tag shows the gross vehicle pounds for which chain size is intended for use. **Made in USA.**

Part No.	Size	Rating	Wt.	SPECIAL
PC 8607570	5/16" x 60"	16,100 lb.	7 lbs.	\$ 134.00
PC 8607190	3/8" x 59"	20,200 lb.	9 lbs.	113.00
PC 8607578	1/2" x 70"	40,500 lb.	17 lbs.	170.00

Tow Chains

Binder Chains - Grade 70 • "Peer-Gold" Finish
With Grab Hook Each End



Part No.	Chain Size	Grade	Working Load-Lbs.	Wt.	SPECIAL
PC 52623-533	3/8" x 20'	#70	6600	32 lbs.	\$ 112.00



DMI Hitches

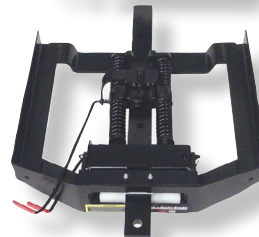

Cush'N Combo Hitch Frame (Flat Bar)

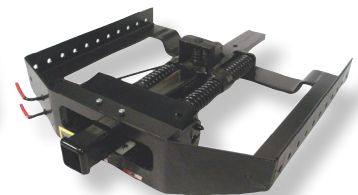

Quic'N Easy Hitch Frame (Receiver)

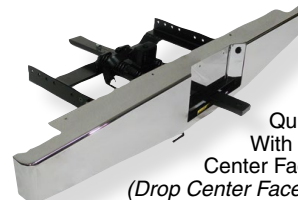

Quic-Cush'N 2 With Chrome Drop Center Face Channel Added (Drop Center Face Channel Sold Separately)

Call for Pricing on the Various Mounting Brackets

Part No.	Item Description	Model Year & Bed Options	Drive Options	Dimensions	Wt.	SPECIAL
UI 4707007	Quic'N Easy Hitch Frame	All Years/Options	2wd & 4wd	37 x 30 x 7	150	\$ 814.00
UI 4709001	Cush'N Combo Hitch Frame	All Years/Options	2wd & 4wd	40 x 30 x 7	150	787.00
UI 4707001	Quic-Cush'N 2 Hitch Frame	All Years/Options	2wd & 4wd	40 x 35 x 7	152	812.00



Recoil Starter

Honda & CRX Engine Repair Parts Available!



SUMMER 2024 NH3/EQUIPMENT SPECIALS

VISIT DULTMEIER.COM FOR NEW ITEMS AND MORE SPECIALS! GOOD THRU 9/13/24

We Stock Parker NH3 Hose

Goodall is Available!



7262

Nylon Braid
(6-Year Removal Date)
Stock

7261

Stainless Braid
(8-Year Removal Date)
Available - Call for Details

— Custom Sizes Available —

Part No.	I.D.	O.D.	Ends	Length	Bend Radius	SPECIAL Price
ST AN05015	1/2"	.095"	1/2" MPT	15'	5"	\$ 156.00
ST AN075015	3/4"	1.25"	3/4" MPT	15'	8"	196.00
ST AN10003	1"	1.51"	1" MPT	3'	10"	73.70
ST AN10005	1"	1.51"	1" MPT	5'	10"	99.90
ST AN10010	1"	1.51"	1" MPT	10'	10"	162.00
ST AN10012	1"	1.51"	1" MPT	12'	10"	184.00
ST AN10015	1"	1.51"	1" MPT	15'	10"	223.00
ST AN10020	1"	1.51"	1" MPT	20'	10"	283.00
ST AN12503	1-1/4"	1.78"	1-1/4" MPT	3'	12"	131.00
ST AN12505	1-1/4"	1.78"	1-1/4" MPT	5'	12"	169.00
ST AN12510	1-1/4"	1.78"	1-1/4" MPT	10'	12"	262.00
ST AN12512	1-1/4"	1.78"	1-1/4" MPT	12'	12"	301.00
ST AN12515	1-1/4"	1.78"	1-1/4" MPT	15'	12"	356.00
ST AN12520	1-1/4"	1.78"	1-1/4" MPT	20'	12"	453.00
ST AN15010	1-1/2"	2.03"	1-1/2" MPT	10'	14"	417.00
ST AN15012	1-1/2"	2.03"	1-1/2" MPT	12'	14"	475.00
ST AN15015	1-1/2"	2.03"	1-1/2" MPT	15'	14"	580.00
ST AN15018	1-1/2"	2.03"	1-1/2" MPT	18'	14"	679.00
ST AN20015	2"	2.75"	2" MPT	15'	16"	945.00
ST AN20020	2"	2.75"	2" MPT	20'	16"	1107.00

Flexible Metal Hose Assemblies

For NH3 and LPG

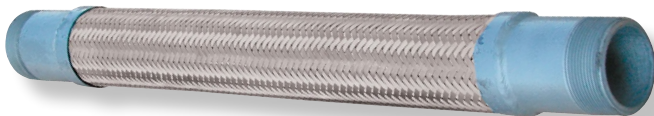

Special Sizes & Lengths Available!

Double Braid with Schedule 80 MPT Ends

Part No.	Description	Max. PSI @ 70° F.	Wt.	SPECIAL
GP 8PCD12A	1" x 12" with Sch. 80 Seamless MPT.....	900	4 lbs.	\$ 105.00
GP 10PCD24A	1-1/4" x 24" with Sch. 80 Seamless MPT....	850	6 lbs.	146.50
GP 12PCD24A	1-1/2" x 24" with Sch. 80 Seamless MPT....	750	8 lbs.	130.00
GP 16PCD24A	2" x 24" with Sch. 80 Seamless MPT.....	825	10 lbs.	232.00
GP 24PCD24A	3" x 24" with Sch. 80 Seamless MPT.....	500	17 lbs.	372.00
GP 32PCD24A	4" x 24" with Sch. 80 Seamless MPT.....	370	30 lbs.	481.00

SAFETY DECALS



+ FIRST AID +
WATER

**CAUTION
AMMONIA**

**ANHYDROUS
AMMONIA**

**WEAR YOUR
GOGGLES**

INHALATION HAZARD

ANHYDROUS AMMONIA

More Decals
Available!



NH3 Tank Valves & Fittings

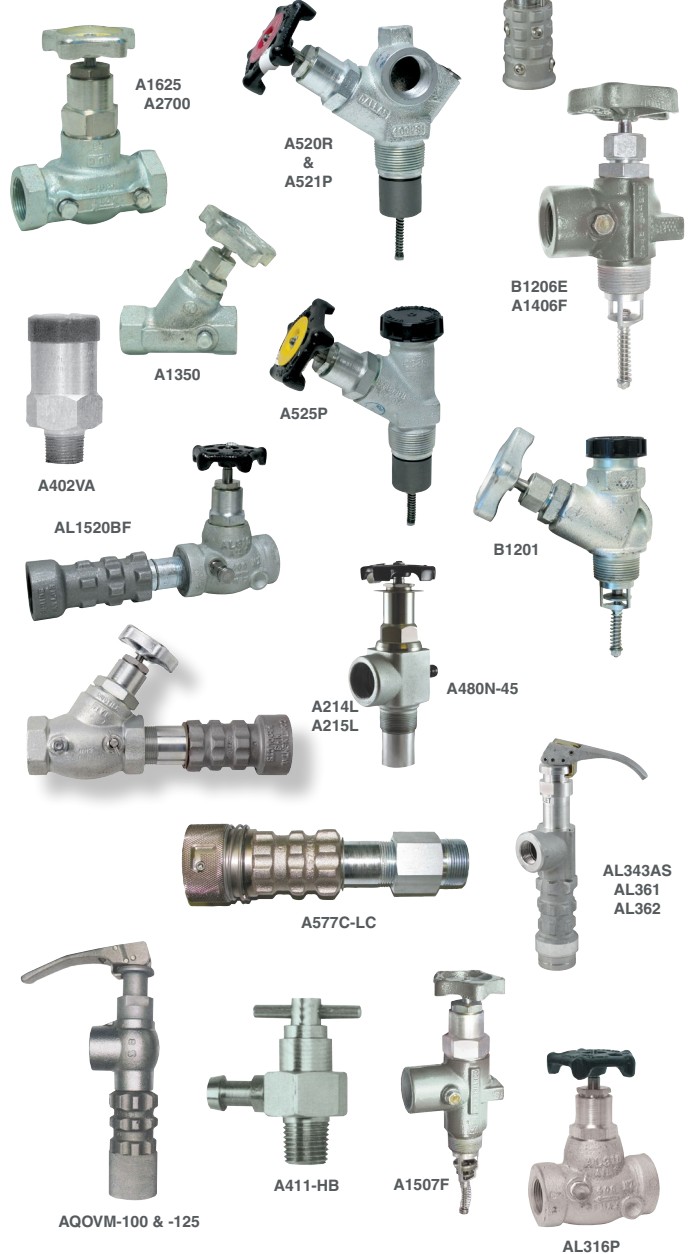

SPECIAL PRICES ON SELECT CONTINENTAL & SQUIBB TAYLOR VALVES:

CN A400	\$31.30	CN A524B	\$24.70	CN B1350	\$139.00	ST A480N-45	\$465.00	CN A1507F	\$413.00
CN A400A	\$31.50	CN A525B	\$39.80	CN B526C	\$78.60	ST A525P	\$210.50	ST AL361	\$500.00
CN A402VA	\$57.20	CN A577B	\$76.60	CN A577C	\$136.00	ST A520R	\$276.50	CN A2525	\$239.00
CN A417A	\$230.00	CN B1201	\$187.00	ST A521P	\$183.00	ST AL1520BF	\$280.00	CN A1406F	\$297.00
CN A411	\$16.30	CN A411-HB	\$43.90	CN B1206E	\$178.00	CN A214L	\$283.00	CN A215L	\$378.00
STAR491NF-70	\$341.00	CN A1000	\$103.00	CN A1625	\$246.00	ST AL343AS	\$509.00	ST A493NR-95	\$512.00
ST AL362	\$543.00	ST A484N-45	\$335.00	CN A577C-LC	\$289.00	ST AL316P	\$440.00		
CN AQOVM-100	\$471.00	CN AQOVM-125	\$462.00						

Call for Pricing On Orders of 25+ Assorted!



SUMMER 2024 NH3/EQUIPMENT SPECIALS

VISIT DULTMEIER.COM FOR NEW ITEMS AND MORE SPECIALS! GOOD THRU 9/13/24

WAKO Side Mount NH3 Knives



Part No.	Description	Price	SPECIAL
WC MAG40	7/16" Side Mount with 3/8" Tube	\$ 57.20	SPECIAL 5% Discount On 50+ One Item
WC MAG40BTS	7/16" Side Mount with 3/8" Tube, with Sealer	65.50	
WC MAG50	1/2" Side Mount with 3/8" Tube	59.70	
WC MAG50BTS	1/2" Side Mount w/3/8" Tube, with Sealer	72.00	
WC W154	1/2" Gopher Knife with 3/8" Tube	55.30	
WC W158	MAG50 Knife with 3/8" & 3/4" Double Tube	83.90	

Mole Style Knives for Toolbars

- Excellent sealing & wearing characteristics.
- Hard tapered facing plate lifts & splits the soil and has superior ground penetration.
- Standard with 3/8" NH3 tubes; 3/8" x 3/4" vapor tubes models also available.
- Mini-Mole Knife is great for side dressing; less disturbance & only 1-1/2" wide.
- We Carry Hi-Pro, Shield & Wako.



Part No.	Description	Price	SPECIAL
HP B33MOLE	B33 Mole Knife	\$ 46.10	Take 5% Additional Discount On 50+ Of One Item
HP B33MOLE-X	B33 Mole with Vapor Tube	57.20	
HP MINIMOLE	Mini-Mole Knife	46.10	
HP MINIMOLE-X	Mini-Mole with Vapor Tube	57.20	
BE DF-1PM	Shield Knife	61.10	
BE DF-1PM34DA	DF-1PM with Vapor Tube	92.20	

Spring Shanks



Part No.	Description	Price	SPECIAL
BE CS1236	BlueJet Shank	\$ 139.00	SPECIAL 5% Discount On 10+ One Size
BE KSC1295	2x1 BlueJet Shank	93.10	
BE KSC1298	2x1 DMI Shank	94.50	

Hose Union Adapters

Zinc-Plated Steel - Not A Live Swivel -

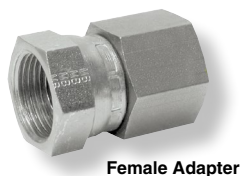

Female Adapter



Male Adapter

Part No.	Size	Style	SPECIAL
HH 987	1"	FPT x FPT	\$ 7.40
HH 977	1"	MPT x FPT	6.70
HH 993	1-1/4"	FPT x FPT	21.30
HH 979	1-1/4"	MPT x FPT	14.50

NH3 Float Gauges

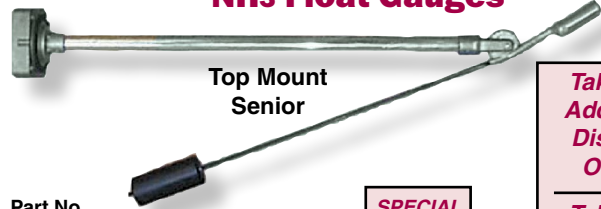

Top Mount Senior

Part No.	Description	Price	SPECIAL
ST AA214E	41" Top Mount	\$ 62.60	SPECIAL 10% Additional Discount On 10+
ST AA240A	46" Top Mount	61.60	
ST A6480-13	41" Top Mount, S.S.	325.00	
ST A6480-12	46" Top Mount, S.S.	324.00	

Many Other Models Available!

Take 10% Additional Discount On 10+

Take 15% Additional Discount On 25+

NH3 GAUGES Stainless Stems



Part No.	Range	Type	Dial	Conn.	SPECIAL
AH A620	60 PSI	Dry	2-1/2"	Bottom	\$ 11.20
AH A1520	160 PSI	Dry	2-1/2"	Bottom	11.20
AH A420	400 PSI	Dry	2-1/2"	Bottom	11.20
AH ASG604	60 PSI	Dry	4"	Bottom	21.90
AH ASG4004	400 PSI	Dry	4"	Bottom	21.90

*Less 10% On 20 or More

Squibb-Taylor NH3 Breakaway Couplers for Toolbars

- No required replacement date
- Mounts in your existing full swivel bracket
- Stainless steel construction - no maintenance required.

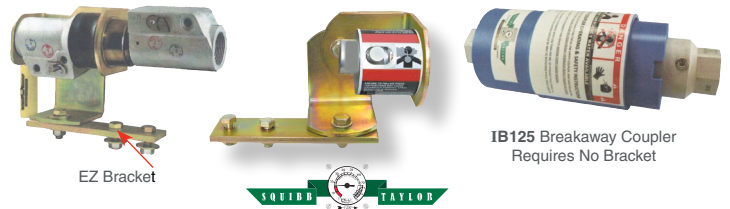

EZ Bracket

IB125 Breakaway Coupler Requires No Bracket

Part No.	Description	Price	SPECIAL
ST FM126-1000	1-1/4" Break-A-Way Coupler, less bracket	\$ 830.00	SPECIAL 10% Additional Discount On 10+
ST EZ-BRACKET	"EZ" Bracket for FM126	180.50	
ST IB125	1-1/4" Breakaway	1412.00	
PA 4500-6	1" Coupler with 1" FPT Male Tip & Clamp Assembly	499.00	SPECIAL 10% Additional Discount On 10+
PA 4500-6M	1" Coupler with 1-3/4" Acme Tip & Clamp Assembly	483.00	
PA 4500-7	1-1/4" Coupler with 1-1/4" FPT Male Tip & Clamp	618.00	

* Use 14" Minimum Length NH3 Hose on Both Sides of Coupler.



High Flow NH3 Coupler

This coupler was designed to have superior flow, reliability and long service life. Stainless steel expansion collet, hard coated aluminum guide spiders and stainless sleeve for reliability and long service life. Mounting bracket is included.

- 1-1/4" size provides 63 GPM at 5 PSI pressure drop.
- 1-1/2" size provides 65 GPM at 3 PSI pressure drop.
- Stainless sleeve on male half prevents freezing.
- Two bleeder valves included.
- No required replacement date.

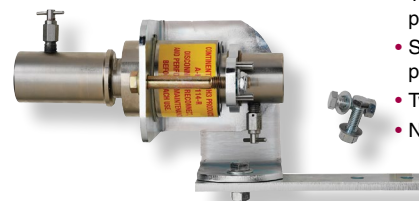

Part No.	Description	Price	SPECIAL
CN AHFC114	1-1/4" High Flow Coupler	\$ 637.00	SPECIAL 10% Additional Discount On 10+
CN BSWV150G	1-1/2" High Flow Coupler	1091.00	



SUMMER 2024 NH3/EQUIPMENT SPECIALS

VISIT DULTMEIER.COM FOR NEW ITEMS AND MORE SPECIALS! GOOD THRU 9/13/24

Flow Meters & Valves for NH3



Part No.	Description	SPECIAL	
RV RFM60S	1-1/2" Flowmeter	\$ 1095.00	* Includes Raven Connection Harness.
KZ S8F33-1CE9S-C01	1" NH3 On/Off *	427.00	
KZ S8F33-1CE9S-D01	1" NH3 On/Off	495.00	
KZ 67G22-10DY0-CF1	1-1/4" NH3 On/Off *	632.50	



Part No.	Description	SPECIAL
CN ACCU-COOLER	†1-1/2" Horiz. Cooler with Brackets For Raven.....	\$ 1605.00

† This Kit Does Not Include Strainer, Meter, Valves or Pipe Fittings. Bolts Directly into RAVEN Accu-Flow Systems.

NH3 Section Control Kits

Save 7 to 12% Product in A Single Application!

Save NH3 product and money with Section Control Systems.

Use these NH3 "Section" Control Kits in combination with Raven, GS@ and other Automatic Rate/Section Controllers, to shut off tool bar sections when crossing into a previously applied area. Prevents duplicate application in these areas. Kits include all items shown including back check valve, Continental's highly accurate A360SP Splitter, KZ's 1" stainless NH3 valves with 12 volt motors, Continental's MVD manifolds, pressure gauges, mounting brackets and miscellaneous plumbing. **All hoses sold separately.**

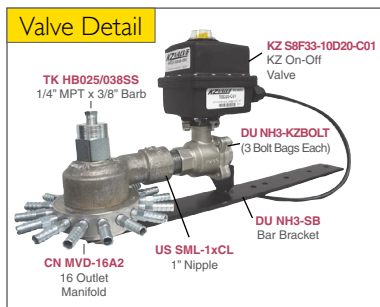

Part No.	Description	SPECIAL
DU NH3-3SECT	3 Section NH3 Control Kit Less Hoses	\$ 3750.00
DU NH3-4SECT	4 Section NH3 Control Kit Less Hoses	4631.00
DU NH3-5SECT	5 Section NH3 Control Kit Less Hoses	5513.00



NH3 Control-Metering Systems with Heat Exchanger



45 GPM & 70 GPM

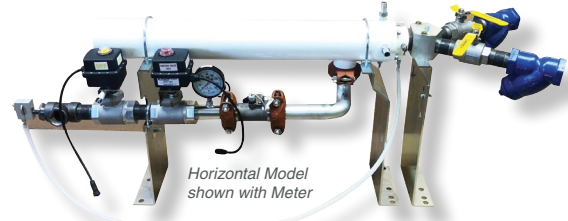

High Capacity, 1-1/2", 45 GPM NH3 Control-Metering Systems with Heat Exchangers. These kits come complete with heat exchangers, mounting brackets, control and shut-off valves and all required plumbing. All that's required is a controller and wire harness. Includes 1-1/4" full port, 120 degree control valve that increases your accuracy more than typical 90 degree control valves. Twin 1-1/4" valves also provide excellent accuracy and control at low rates as well as high rates.

Standard Features

- 45 GPM 1-1/2" System Complete with valves, forged steel fittings & mounting brackets.
- Heat Exchanger Includes Stainless Inner Tubes & Bonnets.
- Inlet Y-Strainer & Stainless Steel Ball Valve Included.
- 12-Volt Control & Shut-Off Valves with KZ Motors (Two Valves System Provides Optimal Accuracy).
- Heat Exchanger can be disassembled for Easy cleaning & maintenance.
- 1-1/2" Stainless Flow Meter (Sold Separately on LM Systems).
- Preassembled for Easy Installation.
- Systems with Meters Include Raven Stainless Meter.

Part No.	Description	SPECIAL
CN ASF3000GH-M	1-1/2" Horizontal System With Raven Meter.....	\$ 5845.00
CN ASF3000G-M	1-1/2" Vertical System With Raven Meter.....	5826.00
CN ASF3000BD	Dual Heat Exchanger, Horizontal With Raven Meter	8385.00
CN ASF3000GHY2KT	70 GPM With Dual Valves, 2 Inlets.....	6326.00
RV RFM60S	1-1/2" Stainless Raven Meter.....	CALL
CN ABVT125SO	* 1-1/4" On/Off FP Valve.....	769.00
CN ACVT125	* 1-1/4" Regulating FP Valve.....	906.00
CN ACCU-COOLER	Retrofit Kit - Direct Repl. for RAVEN AccuFlow..	1605.00

* Includes Raven Conxall Connector.



RAVEN INDUSTRIES

Automatic Rate Controller

with Manual Section Controls (Not for Automatic Section Control) - Other Consoles Available -

Part No.	Consoles Only	SPECIAL
RV SCS450SI	6-Section Console	\$ 2499.00

RAVEN INDUSTRIES

AccuFlow™ Vortex System

Maximize levels of performance with the Raven AccuFlow™ Vortex cooler. The AccuFlow™ uses super cooling technology to stabilize NH3 as a liquid for superior accuracy and control. This pre-assembled system is the epitome of time savings. The AccuFlow™ Vortex allows you to apply more anhydrous at faster speeds and cooler temperatures, with less weight on the toolbar.

Other Key Benefits:

- Single or dual valve systems.
- Capable of up to 8 Section & automatic section shut-off.
- Simple cooler disassembly for easier maintenance.
- Increased capacity with smaller footprint on toolbar.
- Advanced controls for high & low end application.
- ISO Compatible.

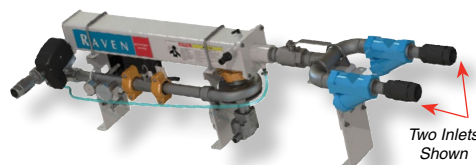

Part No.	Description	SPECIAL
RV 718	AccuFlow™ Vortex with Dual Valves, 1 Inlet.....	10066.00
RV 716	AccuFlow™ Vortex with Dual Valves, 2 Inlets.....	11260.00

RAVEN INDUSTRIES



SUMMER 2024 NH3/EQUIPMENT SPECIALS

VISIT DULTMEIER.COM FOR NEW ITEMS AND MORE SPECIALS! GOOD THRU 9/13/24

— SAFETY EQUIPMENT —



Safety Water Containers

Five gallon durable plastic containers mount on applicator and nurse tanks. Heat resistant. Included is a clear hose that fastens to the container when not in use.

Part No.	Description	Price	SPECIAL
PH 76410	Top Mounted Water Container (5-Gal.) Grey	\$ 66.90	Take 5% Additional Discount On 5+ Of One Size
PH 76411	Side Mounted Water Container (5-Gal.) Grey	66.00	
LL R70	Top Mount Water Container, Red (6.9 Gal.)	151.00	

EPDM Applicator Hose

EPDM, 2-Braid, low pressure economy hose with good flexibility. The 3/8" hose has good low pressure/temperature characteristics for NH3 application. Black tube and cover. 150 psi maximum @ 70° F. **Not for high pressure use.**

Economy



Part No.	Size	SPECIAL Per Ft.	Take 25% Discount On Full Reel
GA 3204EB-3/8	3/8"	\$ 0.99	

- Other Sizes Available -

Gloves for NH3 & Chemicals



Part No.	Description	Price	SPECIAL
BS 7714R	PVC GLOVES: Lined for NH3, 14"	\$ 4.90	Ask About Massive Quantity Discounts!
BS 7712R	PVC GLOVES: Lined for NH3, 12"	4.30	
BS 737	UNLINED RUBBER GLOVES: For Chemicals, 15", 22 mil, Large	10.70	
BS 727-11	Light Duty UNLINED RUBBER GLOVES: For Chemicals, 14" XL	3.00	

EVA Applicator Tubing Non-Braided

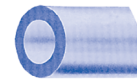

Part No.	Reel LENGTH	Reel Price	Take 10% Discount On 12+
GD V1160-3/8	500'	\$ 195.00	
GD V1160-1/2X500	500'	235.00	
GD VB1170-3/8	* 500'	199.00	

* Black Tubing

Cut Resistant PVC Lined Gloves Fully Coated with Seamless Kevlar® Liner

Fully Coated PVC Gloves with seamless Kevlar® liner for excellent abrasion and cut resistance. Rough coated palms provide great grip. Good choice for NH3, Oils and chemicals resistant to PVC (Not for use with LP gas). EN388:4332 rating of 4 for abrasion, 3 for cut resistance and 4 for tear resistance. 12" length. Color is blue. Liner is treated to resist germs and odors. Sold by the pair or box.



Part No.	Size	Length	Box of 12 Discount	Per Pair SPECIAL
BS 8658KL	Large	12"	10%	\$ 15.50
BS 8658KX	X-Large	12"	10%	15.50

Safety Goggles



Part No.	Description	CASE OF 72 DISCOUNT	SPECIAL
WL 552	Safety Goggles - Non Vented..	25%	\$ 5.40
WL 551	Safety Goggles - Vented.....	25%	4.85

Premier Safety Goggles

Fogless High Performance Safety Goggles for protection against splashes or spills. Form fitting comfort and superior all day protection.



Part No.	Description	* Std. Pkg.	SPECIAL
WL 25180	Premier Safety Goggles, Clear Lens	40	\$ 11.00
WL 25153	Premier Safety Goggles, Grey Lens	50	10.30

* 15% Standard Package Discount

Grain Cart Fire Fighter Sprayer

FEATURES:

- 150 Gallon Tru-Kleen™ Tank with Drain – 13 Minute Runtime
- 205PH5 Transfer Pump with 5.5 HP Honda GX160 Engine
- 100' 3/4" Kink-resistant PVCs Hose
- Multi-Position Quick Release Hose Wrap
- Can be Used With or Without Mounting Kit



Sprays Up to 40 Feet!

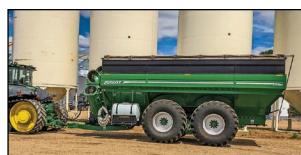

Part No.	Description	SPECIAL
FS GUARD-150	150 Gallon Grain Cart Fire Fighter	\$ 2682.00
FS GUARD-MK-RM	Grain Cart Rear Mount Kit	872.00
FS GUARD-MK-SM	Grain Cart Side Mount Kit	480.00

Note: Unit & Mounting Brackets Sold Separately.

UTV Skid Sprayer

UTV100EC-3KZ (Boom Sold Separately)

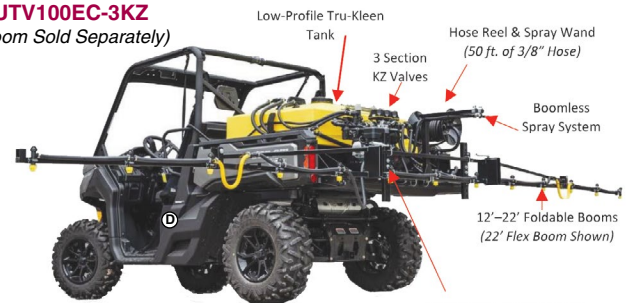

4 HP Honda Engine w/ Ace Centrifugal Pump (57 PSI - 22.5 GPM)

Many Models Available - Call with Specifications!

FEATURES:

- Powerful 4 HP Honda GX120 Engines
- Ace Centrifugal Pumps—57 PSI / 22 GPM
- Adjustable Swing-Away Control Arm with Master Shut-off
- Cab Control Pressure Regulator & Liquid-Filled Gauge
- Low-Profile Tru-Kleen™ Tank "Empties to the Last Drop!"
- Hose Reel & Spray Wand Come Standard
- High-Quality TeeJet & Banjo Plumbing for Boom or Boomless Systems

Call for Pricing!



SUMMER 2024 NH3/EQUIPMENT SPECIALS

VISIT DULTMEIER.COM FOR NEW ITEMS AND MORE SPECIALS! GOOD THRU 9/13/24

Remote Shut-Off Systems • Decals & Equipment

Use Squibb-Taylor's NH3 Remote Shut-Off Systems to improve overall safety of your NH3 storage plant. The components shown below allow you to set up a system for both manual and remote shut-off of all your N550/N551 emergency shut-off valves in (3) important ways: **1)** From a remote office or shop. **2)** From a handheld remotes carried by your plant operators **3)** From various push button stations near your storage tank (*E-Stops*). **Note: Only for NH3 Use; Do Not Use with LPG storage systems or other systems storing flammable liquids.**

RSD-E Remote Controlled Shut-Off Panel

The **RSD-E Remote Controlled Shut-Off Panel** is the main component of your complete NH3 shut-off system. It includes a built in receiver and one handheld transmitter. It is normally installed near the storage tank and includes a NEMA 4 outdoor rated enclosure. Can be located up to 300 ft. from the handheld transmitters (*through normal building walls*) and up to 400 ft. in "line of sight" with no walls.



Includes a 115V power cord with plug. It also includes a 12 volt wire harness to supply the P810 shut off devices on each N550/N551 emergency shut off valve. This 12 volt harness can also be wired to the RSD-A box (*air solenoid junction box*) for use with P539A pneumatic controlled shut off devices. 15 Amp rating will close twenty-five P810 valve shut offs simultaneously. Fail safe design provides for positive shut-off. Can be used with up to (15) RDS-E1 handheld transmitters.

Part No.
ST RSD-E Remote Controlled Shut-Off Panel.....

**Call for
System Pricing**

CORKEN. Coro-Vane® Pumps for LPG & NH₃

CORKEN® base mounted pumps are complete with base, V belt drive assembly and belt guard, 3 PH TEFC motor. Pumps are standard with FPT bolt-on flanges. Use 1-1/4" relief valve on 521/522 pumps; 2" on 1021/1022 pumps.

Coro-Vane® is a positive displacement pump line that is designed for stationary applications at bulk plants.

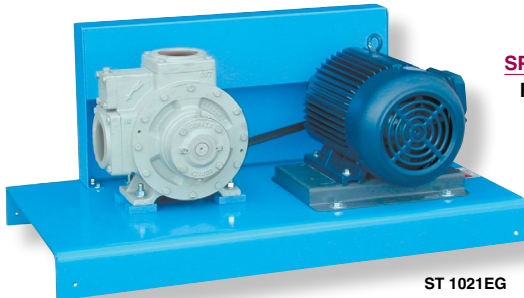

SPECIFICATIONS:

RPM: 420 - 950

Temperature:

-25°F to 225°F

Connections:

521: 2" x 2"

1021: 3" x 3"

Part No.	Description	Wt.	SPECIAL
ST 521EG	2" Pump Only for Plant Use.....	132 lbs.	\$ 4047.00
ST 521EG-103	2" Pump with 5 HP/3PH Motor, for LPG.....	450 lbs.	4722.00
ST 521EG-103A	2" Pump with 5 HP/3PH Motor, Base & Belt Drive for NH3.....	400 lbs.	5791.00
ST 1021EG	3" Pump only for plant use.....	200 lbs.	5278.00
ST 1021EG103A	3" Pump with 10HP/3PH Motor, Base & Drive.....	510 lbs.	7707.00
ST LGLD3F	3" Blackmer NH3/LPG Pump Only.....	-	5104.00
DU Z3500-10	3" Pump with 10 HP/3PH Motor, Base & Belt Drive.....	-	7212.00
DU Z3500-15	3" Pump with 15 HP/3PH Motor, Base & Belt Drive.....	-	8856.00
ST T166-1.25	1-1/4" Bypass Valve, <i>Corken</i> (Range: 50-150 PSI).....	13 lbs.	515.00
ST T166-1.5	1-1/2" Bypass Valve, <i>Corken</i> (Range: 50-150 PSI).....	16 lbs.	515.00
ST BV1.25	1-1/4" Bypass Valve, <i>Blackmer</i> (Range: 91-125 PSI).....	13 lbs.	554.00
ST BV2-70	* 2" Bypass Valve, <i>Blackmer</i> (Range: 40-71 PSI).....	-	916.00
ST BV2	* 2" Bypass Valve, <i>Blackmer</i> (Range: 91-125 PSI).....	45 lbs.	898.00
ST 2904X2	Repair Kit for 521/522 Pump.....	-	1654.00
ST 2906X2	Repair Kit for 1021/1022 Pump.....	-	1819.00
ST 1769XRA6	Seal Kit for 521/2021EG.....	-	329.00

* Use BV2 for propane in most cases; use BV2-70 for NH3.

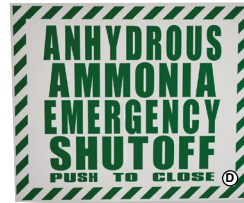

650088

"Push to Close" Decal & Sign Post

- Mount Near Your Emergency Stop Shut Offs.
- 10" High x 12" Wide.

Part No.		SPECIAL
ST 650088	NH3 Emergency Shut Off Decal.....	\$ 12.00
ST 404186	Sign Post for 650088 with 10" x 12" Top.....	122.00

Complete NH3 Plant Installs Available

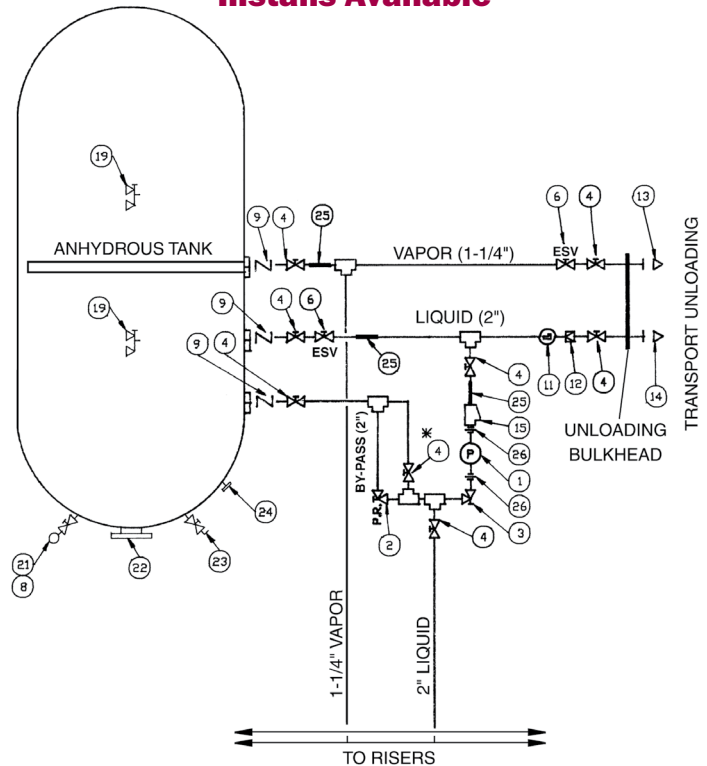

**Maximize Plant Efficiency
with Dultmeier!**

**Forged Steel Fittings
Schedule 80 In Stock
1/4" - 4" Available
Call Us for Your Needs**



— NH3 PLANT EQUIPMENT —

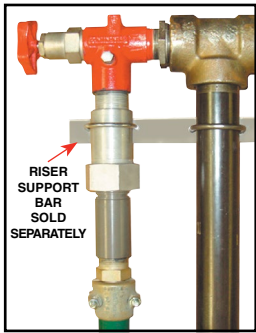

Riser Safety Shear

- Pull away protection for Anhydrous Risers
- Rugged stainless steel and nylon check valves
- 5 Year unconditional warranty
- Available in 1" and 1-1/4"

Part No.	Description	SPECIAL
CN A53RSS	1" MPT 53 GPM. Use with Vapor Valves	\$ 514.00
CN A72RSS	1-1/4" MPT 72 GPM. Use with 70 GPM valves	592.00
CN A98RSS	1-1/4" MPT 98 GPM. Use with 95 GPM valves	691.00

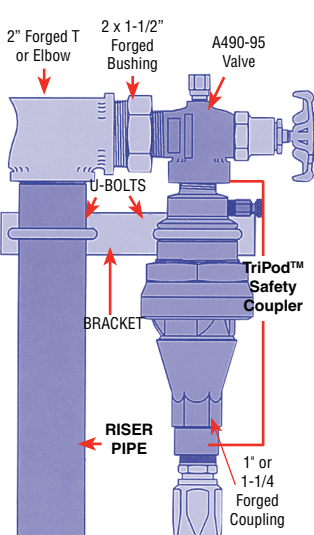

Riser Safety Shear "Tripod"™

Pull Away Protection For Anhydrous Risers

- Pull Away Protection for Anhydrous Risers.
- 5 Year Unconditional Warranty.
- Stainless Steel Construction with Teflon® Back Check Seats for Long Term Dependable Operation.
- Non-Destructive Releasing Mechanism is Easily Reconnected After a Pull Away.
- Double Back Checks Minimize Product Release from Both the Riser and hose.

Part No.	MPT Each End	Flow	SPECIAL
ST TP5	Vapor 1"	55 GPM	\$ 1247.00
ST TP6	Liquid 1"	77 GPM	1546.00
ST TP7	Liquid 1-1/4"	126 GPM	2101.00

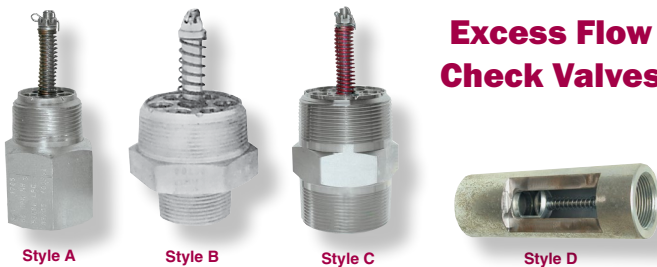

Excess Flow Check Valves

The 1700 Series Excess Flow Check Valves are designed to close when liquid flow exceeds the valve's "Closing Flow". They are required on all 1-1/4" and larger tank ports. Cadmium plated steel, bar stock body and component parts. Stainless steel springs.

Part No.	PIPE THREAD SIZE	STYLE	Closing Flow GPM of Liquid NH3 at 100 PSI	SPECIAL
ST A1705-50	1-1/4" M x 1-1/4" FM	A	50	\$ 178.50
ST A1710-95	2" M x 2" FM	A	95	317.00
ST A1708-95	2" M x 1-1/4" M	B	95	302.00
ST A1711-95	2" M x 2" M x 1-1/4" FM	C	95	375.00
ST A1713-165	3" M x 3" M x 2" FM	C	165	586.00
ST A1713-225	3" M x 3" M x 2" FM	C	225	599.50
CN AEFV45	1-1/4" F x 1-1/4" F	D	42	165.00

Emergency Shutoff Valves (ESV)

FISHER

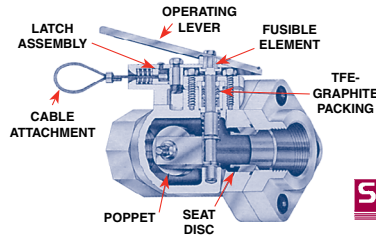

Snappy Joë

N551-16

Emergency Shutoff Valves are designed for emergency shut-off in the event of a hose rupture or piping break at the transfer area. Valves are manually opened and can be closed manually at the installed location or remotely by either cable or air cylinder (sold separately).

Part No.	PORTS	FLOW @ 1 PSIG DIFFERENTIAL	SPECIAL
ST N551-10	1-1/4" FPT	125 GPM	\$ 637.00
ST N551-16	2" FPT	150 GPM	1191.00
ST N551-24	3" FPT	280 GPM	1600.00

Back Check Valves



"A" Series

Back check valves allow flow in one direction only to prevent backflow. They are used in liquid filling connections on bulk tank, delivery trucks and unloading bulkheads for NH3/LPG.

The "A" Series are steel back checks with soft seat internals.

Part No.	Size	GPM @ 10 PSI Diff.	Material	SPECIAL
ST A1727	1-1/4 MPT x 1-1/4 FPT	77	Steel	\$ 206.00
ST A1728	2" MPT x 2" FPT	150	Steel	243.00
ST A1729	3" MPT x 3" FPT	250	Steel	549.00



TITAN Ductile Iron Y-Strainers

for NH3 & LPG
640 PSI WOG



Part No.	Size MNPT	Plug Size	SPECIAL
ST 200902	1/4" FNPT	1/4"	\$ 27.20
ST 200907	3/8" FNPT	1/4"	25.90
ST 200912	1/2" FNPT	1/4"	39.00
ST 200917	3/4" FNPT	3/8"	46.60
ST 200922	1" FNPT	3/8"	59.50
ST 200927	1-1/4" FNPT	3/4"	64.50
ST 200932	1-1/2" FNPT	3/4"	83.40
ST 200937	2" FNPT	1"	142.00
ST 200942	2-1/2" FNPT	1-1/2"	320.00
ST 200947	3" FNPT	1-1/2"	476.00

40 Mesh standard - 20 & 80 Mesh screen sizes available. Plugs installed from factory.



SUMMER 2024 NH3/EQUIPMENT SPECIALS

VISIT DULTMEIER.COM FOR NEW ITEMS AND MORE SPECIALS! GOOD THRU 9/13/24

HINIKER

Nitro-Lert™ for Rate Control Systems

The **Hiniker Nitro-Lert Anhydrous Ammonia Knife Monitor System** is the industry leading knife monitoring system which alerts operators to individually blocked manifold outlets, lines, or knives. In-line sensors monitor each outlet's flow variations, helping catch and correct potential application inconsistencies while also reducing downtime and overall product costs.



FEATURES:

- Monitor up to 80 individual outlets
- Detects plugged knives when operator turns flow off and on
- Signals potentially broken/blocked knives due to flow variation
- Audible system alarms alert operator to potential malfunctions
- User friendly interface — easy-to-read bar graph in-cab display monitor



HINIKER

Nitro-Lert Console

Part No.	Description	SPECIAL
HK 8035	Nitro-Lert Console Kit.....	\$ 1291.00

Line Sensors

Part No.	Description	SPECIAL
HK 36021004	3/8" Line Sensor.....	\$ 226.00
HK 36021017	1/2" Line Sensor.....	226.00

Adapter Cables

Part No.	Description	SPECIAL
HK 38818018	Adapter Cable for JD Greenstar, 10'.....	\$ 515.00
HK 38818019	* 12' Adapter Extension Cable	138.00
HK 38818020	* 20' Adapter Extension Cable	145.50
HK 38818021	Adapter Cable for Raven 440/450/460.....	360.00

Line Sensor Cables

Part No.	Description	SPECIAL
HK 38818010	10' Line Sensor Extension Cable	\$ 58.20
HK 38818011	15' Line Sensor Extension Cable	60.10
HK 38818012	20' Line Sensor Extension Cable	65.00
HK 38818013	25' Line Sensor Extension Cable	65.00
HK 38818014	30' Line Sensor Extension Cable	70.80

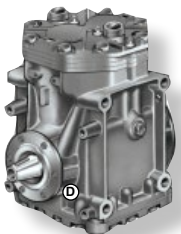

VKC

Vapor Transfer Compressor Unit

For Anhydrous Ammonia



The York Two-Cylinder Automotive Compressor used on vapor transfer units has cast iron cylinder liners, die-cast aluminum head and compressor body, ball-type main bearing and single-ring aluminum pistons. The York Compressor is 10 C.F.M. with forced feed lubrication. **NOTE:** Use Texaco Capella "E", Suniso #5 or equivalent oil. 1/2" Ports.

VK1 VAPOR TRANSFER COMPRESSOR with 5.5 H.P. Honda Engine and York Compressor mounted on a steel base for NH3. Capacity is 20 to 50 GPM depending on pipe diameter. **VKE** includes electric motor.

Part No.	WT.	SPECIAL
CN VK1	Compressor Unit. With	
	5.5 H.P. Honda Engine	54 lbs. \$ 3285.00
CN VKC	* Compressor Only.	18 lbs. 663.50

* Does Not come with inlet and outlet flanges.

N-Serve Easy Caddy System

- Dura-Pump™ Easy Caddy Pumping System in Viton®; Approximately 8-10 GPM
- 1" x 12' Discharge Hose & 1" x 5" Suction Hose are Premium XPLE
- Includes Ball Valve Nozzle (Dry Poppet Coupler Also Available)
- Optional Meter Available
- Features 2 Year Maintenance Program



Part No.	Description	SPECIAL
DP E6618NV-12	Easy Caddy N-Serve System, 12 Volt ...	\$ 1600.00
DP E6618NV-110	Easy Caddy N-Serve System, 115 Volt ..	1399.00
DP 3000V	1" Dura-Meter, Viton®.....	309.50

Hose End Swivels for NH3 & LPG

The **Hose End Swivel** increases freedom of movement to make attaching or disconnecting hose end valves easier. It also prevents twisting of the hose. U.L. listed.

- Full bore opening offers no flow restriction.
- Unique TFE Pressure Core™ seal eliminates the need for O-rings or lip seals, giving longer working life.
- Lightweight yet sturdy enough to withstand rough handling.
- 400 PSI maximum working pressure.
- Requires No Lubrication.



Part No.	Connection Size	Diameter	Length	Repair Kit	SPECIAL
ST 107	3/4" MPT x 3/4" FPT	2-11/16"	4-3/16"	ST107-0022	\$ 306.50
ST 109	1" MPT x 1" FPT	3-1/16"	4-3/8"	ST109-0022	254.00
ST 111	1-1/4" MPT x 1-1/4" FPT	3-5/8"	4-3/4"	ST111-0022	414.00

N-Serve Hose Assemblies



Part No.	Description	SPECIAL
GP 4700-1/2X15	1/2" X 15' OAL, Fixed MPT, 316SS Ends	\$ 174.00
GP 4700-1/2X20	1/2" X 20' OAL, Fixed MPT, 316SS Ends	195.00



SUMMER 2024 NH3/EQUIPMENT SPECIALS

VISIT DULTMEIER.COM FOR NEW ITEMS AND MORE SPECIALS! GOOD THRU 9/13/24

Large Plant Pumps to Meet All Your Needs!

Goulds 1750 RPM Pump Units

- 1750 RPM Provides High Flow Rates with Reduced Seal & Bearing Wear, & Reduced Cavitation Potential
- All Iron with 150/125# ANSI Flanges
- Silicon Carbide, Carbon, Viton® Severe Duty Seals
- Back Pull-out Design Reduces Maintenance Time
- Grease Lube Bearings
- **"Premium" Efficiency** Totally Enclosed Fan Cooled (TEFC) Motors
- Flow Rates to 4500 GPM; Heads to 185'
- "Orange Peel" OSHA Approved Coupling Guards



DU GL15F-40

Many Other Models Available!

Part No.	Size	HP	Lb./Gal. Rating	Max Flow
DU GL12A-20	4 x 3	20 HP	11.7	775 GPM
DU GL14E-25A	4 x 3	25 HP	11.7	775 GPM
DU GL14C-40	4 x 3	40 HP	11.7	850 GPM
DU GL15J-30	6 x 4	30 HP	11.7	1060 GPM
DU GL15F-40	6 x 4	40 HP	11.7	1180 GPM
DU GL15D-50	6 x 4	50 HP	11.7	1325 GPM

Call For Current Pricing

Scot Model 56 & 57 Pump Units

- All Iron with 150/125# ANSI Flanges
- 3500 RPM Provides High Flow Rates In An Economical Body Size.
- Sealed Bearings & Viton® Mechanical Seals
- **"Premium" Efficiency** Totally Enclosed Fan Cooled (TEFC) Motors
- "Orange Peel" OSHA Approved Coupling Guards

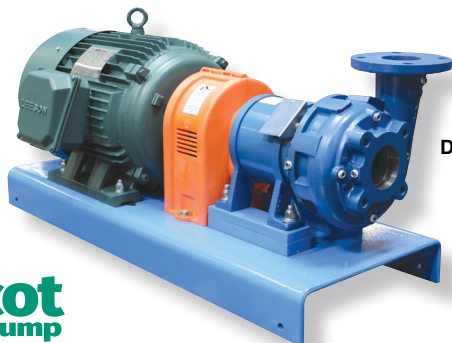

DU FP56F

Part No.	Size	HP	Lb./Gal. Rating	Max Flow
DU FP56F-15	3 x 3	15 HP	11.1	475 GPM
DU FP56F-20	3 x 3	20 HP	11.1	550 GPM
DU FP56F-25	3 x 3	25 HP	11.1	550 GPM
DU FP57-25	4 x 3	25 HP	10.9	900 GPM
DU FP57-30	4 x 3	30 HP	12.5	900 GPM
DU FP57-40	4 x 3	40 HP	11.1	1050 GPM

Call For Current Pricing

Let Our Engineering Staff size the correct pump to meet your flow rate requirements using computer software – Free Analysis!

Call 800-228-9666, ext. 5536

Vertiflo Double "Pressurized" Seal Centrifugal Pump Units



Model 1424

Pumps are long coupled on steel baseplates (powder coated) to Totally Enclosed Fan Cooled (TEFC) motors and include OSHA Approved "Orange Peel" poly coupling guards. Also available with optional stainless impellers or in all 316 stainless construction.



Part No.	Flanged Ports	Flow at 25 PSI	Max. Flow	Lb./Gal. Rating	Motor H.P.	Wt. Lbs.
DU VF4X3-20	4 x 3	610 GPM	660 GPM	11.1	20 HP	675
DU VF4X3-25	4 x 3	760 GPM	760 GPM	15.6	25 HP	675
DU VF5X4-25	5 x 4	760 GPM	760 GPM	12.5	25 HP	750
DU VF6X5-40	6 x 5	1030 GPM	1140 GPM	13.8	40 HP	875
DU VF6X6-40	6 x 6	1125 GPM	1725 GPM	12.5	40 HP	1075
SC 118-000-236V	Pressurized Seal Barrier Fluid Reservoir Kit Less Brkt.					
DU PS-STAND	Steel Bracket for Above Reservoir.....					
DU LUBE-205KV	Lubesite #205 Grease Lubricator Kit.....					

Call For Current Pricing

Self-Priming Pump Units



Cast Iron • Viton® Seals • Premium Efficiency TEFC Motors



BU1533

BU1533 3" Self Priming Pump

- Double Viton® Wet Seal
- 400 Maximum GPM
- 64 Maximum PSI
- 3500 Maximum RPM
- Long Coupled

Electric Motor Model (Long Coupled Version Shown)

Part No.	Size	HP	Lb./Gal. Rating	Max Flow
DU TK33315-3	3 x 3	15 HP	11.7	515 GPM
DU TK44425-3	4 x 4	25 HP	11.7	650 GPM
DU BU1533*	3 x 3	15 HP	11.4	400 GPM
BU SP3450E20TB*	4 x 3	20 HP	11.7	560 GPM

Call For Current Pricing

* Includes double "wet" run dry seal

"Orange Peel" OSHA Approved Coupling Guards



SUMMER 2024 NH3/EQUIPMENT SPECIALS

VISIT DULTMEIER.COM FOR NEW ITEMS AND MORE SPECIALS! GOOD THRU 9/13/24



MP Flomax
DU MP1033
3" • 10 HP • 300 GPM
3 Phase TEFC Motor

\$ 3360.00

"Orange Peel" OSHA Approved
Coupling Guards

Quantity Discounts Available

3" Transfer Pumps

- Self-Priming • Cast Iron
- Viton® Seals

John Blue High Flow
DU BU1533
Double Run Dry Seal
3" • 15 HP • 315 GPM
3 Phase TEFC Motor

\$ 4831.00

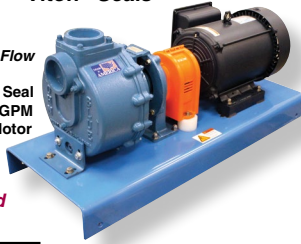

OPW Spring Balance Load Arms

10' or 12'

J32F Load Arm
Swivels Horizontal & Vertically

304 Schedule 10 S.S. Pipe 3858 Ductile Iron Swivel Joint Double Plane (Teflon Seals)

790 "EZ Adjust" Spring Balance

Part No.	Description	NET EA.
DU J32F-3	3" x 10' Load Arm Assembly	\$ 7556.00
DU J32F-312	3" x 12' Load Arm Assembly	8076.00
DU J32F-4	4" x 10' Load Arm Assembly	9213.00
DU J32F-412	4" x 12' Load Arm Assembly	9309.00

2" Bulk Chemical Pumps

Cast Iron & Stainless • Self Priming • TEFC Motors

"Orange Peel" OSHA Approved
Coupling Guards

Part No.	Size	NET EA.
DU MP3510	2" 5 HP, 1 Phase	\$ 2604.00
DU MP3530	2" 5 HP, 3 Phase	2085.00

Quantity Discounts Available



High Capacity Stainless Strainers

Thompson

Extra Large Screens
for Very Low
Pressure Drop

Bottom Cleanout Port
4" • 6" • 8"

150 lb. ANSI Flanges

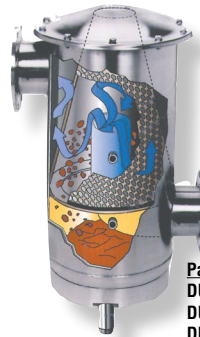

Part No.	Inlet/Outlet Flanged	MAX. GPM	Filter Area Sq. In.	Debris Flush Port	NET EA.
DU ML14B-1/8	4" Flanged	350	367"	2" NPT	\$ 3550.00
DU ML16-1/8	6" Flanged	750	745"	2" NPT	5236.00
DU ML18-1/8	8" Flanged	1300	1559"	2" NPT	CALL

2" 316 Stainless Self-Priming Pump Units

An excellent choice for pumping many chemicals compatible with 316 stainless steel. These pump units consist of 2" x 2" self-priming pumps constructed of 316 cast stainless steel (more durable than stamped stainless pumps). Elastomers are Viton® or EPDM depending upon chemical compatibility. Pumps are long-coupled to Totally Enclosed, Fan Cooled (TEFC) motors (1 or 3 Phase). Heavy duty steel base plates with powder coat paint finish and OSHA approved coupling guards. **Call for chemical compatibility check.**



Quantity Discounts Available

316 SS Pump Units

Part No.	HP	Phase	Elastomer	Max. S.G.	Wt. Lbs.	NET EA.
DU TK3530-SSV	5	3	Viton® Single Seal	1.4	145	\$ 3802.00
DU TK3510-SSV	5	1	Viton® Single Seal	1.4	145	4119.00
DU MP3530-SSV	5	3	** Viton® Single Seal	1.4	145	4325.00
DU MP3510-SSV	5	1	** Viton® Single Seal	1.4	145	4764.00

* Viton® Double Seal with Liquid Reservoir. ** Includes MP SS Flomax Pump.

Scot 316 Stainless Centrifugal Pump Units

Long Coupled; Severe Duty Seals

These 2" x 2" 316 Stainless Centrifugal Long-Coupled Pump Units are an excellent choice for agchemicals, fertilizers, deicing liquids and other corrosive products. Pump wetted parts are Cast 316 Stainless with Heavy Duty Iron Bearing Pedestals (with double seal bearings) and Silicon Carbide/Viton Mechanical Seals (other seals available).

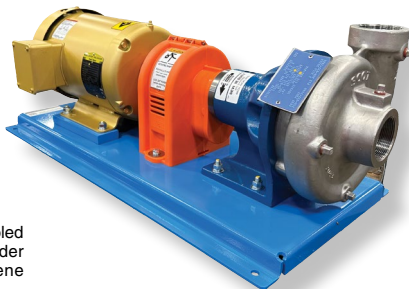

Motors are Totally Enclosed Fan Cooled (TEFC). Steel base plates are powder coated. OSHA Approved polyethylene shaft guards.

Quantity Discounts Available

Part No.	Ports	Max GPM	GPM @ 30 PSI	HP	Phase	S.G. Rating	NET EA.
DU SSD602-51	2" x 2"	150 GPM	135 GPM	5	1	1.45	\$ 5409.00
DU SSD602-53	2" x 2"	150 GPM	135 GPM	5	3	1.45	4868.00



METERS



Mass Meter



Chem Meter
FR TS104A

Legal for Direct Resale

Call for Details & System Pricing!

Pump & Meter Units for Ag-Chemicals

Pump & Meter Unit
for Transfer of
Ag-Chemicals & Other Liquids

The PM2810 is an excellent pump and meter unit for transfer from bulk storage to portable containers. It is suitable for most all agricultural chemicals and herbicides. The 2" self priming Flomax Pump can be supplied either with a single phase or a three phase motor. The 40 GPM TCS Meter is NTEP Labeled. The register will record to 10,000 gallons. A Ticket Printer and Preset Valve are optional at added cost. Tee on pump discharge is included for "recirculation" plumbing back to tank.



Model
PM28105

The pump and meter are plumbed with iron fittings, one 1-1/2" stainless ball valve, cast iron strainer, stainless air eliminator and chemical hose. Steel stand.

Part No.	PUMP & METER UNITS	Wt.	NET EA.
DU PM2810-T	3HP - 3 Ph. Pump & Meter Unit with TCS Meter	200 lbs.	\$ 6780.00
DU PM2810T5	5HP - 3 Ph. Pump & Meter Unit with TCS Meter	235 lbs.	6954.00

Note: Other Motor/Meter Combinations are available.

Keystone Butterfly Valves & Actuators



250 PSI Rating

Stem: 416 Stainless Steel
Disc: 304 Stainless Steel
Seat: EPDM
Body: Cast Iron



Double Acting Actuator

Part No.	Ports	NET EA.
KE 906-20	2"	\$ 127.00
KE 906-25	2-1/2"	155.00
KE 906-30	3"	155.00
KE 906-40	4"	185.00
KE 906-50	5"	244.00
KE 906-60	6"	294.00
KE 790-200	2"-4" Actuator	373.00
KE 790-300	5"-6" Actuator	540.00

*** Discount
5% Off 5+
One Size**

Air Actuated Butterfly Valves

Keystone Series 221 Butterfly Valves with either **Keystone** or **Matrixx Air Actuators**. Available in "double acting" style (air to open and close) or spring return style (air to open, spring closes when air is exhausted). Valves include cast iron bodies, EPDM seats, 316 stainless discs and 416 stainless stems. Valves are rated to 250 PSI and 250° F. Keystone and Matrixx actuators are direct mount (no brackets).

DOUBLE ACTING:

Part No.	Size	Type	* NET EA.
DU A906-20K	2"	Keystone	\$ 486.00
DU A906-30K	3"	Keystone	540.00
DU A906-40K	4"	Keystone	572.00
DU A906-60K	6"	Keystone	856.00
DU A906-20M	2"	Matrixx	881.00
DU A906-30M	3"	Matrixx	909.00
DU A906-40M	4"	Matrixx	1355.00
DU A906-60M	6"	Matrixx	1450.00

**SPRING RETURN:

Part No.	Size	Type	* NET EA.
DU A906-20KSR	** 2"	Keystone	\$ 612.00
DU A906-30KSR	** 3"	Keystone	723.00
DU A906-40KSR	** 4"	Keystone	755.00
DU A906-60KSR	** 6"	Keystone	1219.00

** Note: These are air actuated valves with a spring return to close, when there is a loss of air pressure.



Keystone Valve & Actuator Shown

*** Quantity Discount
Less 5% on 5+**

Air Actuated Stainless Ball Valves

- 2-Piece -



These **Stainless Air Actuated Valves** incorporate a full port 2-piece stainless steel ball valve for great flow rates with minimal pressure drop. The valve features a blowout proof stem for added safety, reinforced PTFE seats and seals for longer life, and a 316 SS (ASTM CF8M) ball for better performance. Actuators are direct mounted creating a compact assembly for tight spaces.

DA Double Acting Actuator Models use an air supply to drive the valve open and closed. The actuator has two supply ports, with one driving the valve open and the other driving the valve closed.

Applications:

- Gas or Liquid Flow Control
- Ideal for Quick Bubble Tight Shut-Off

Also available with electric actuators (weather-proof or explosion-proof). Electric solenoids and limit switches.

Features: Capable of being configured to fit most any application • Vented ball to reduce operating torque • Full port design reduces the pressure drop across the valve. Rated to 1000 PSI at 250° F. and 29" vacuum • 80 PSI required to actuate.

Other Sizes Available

Air-Actuated - Double Acting

Part No.	Description	NET EA.
KC 830652	1" Stainless Ball Valve	\$ 244.00

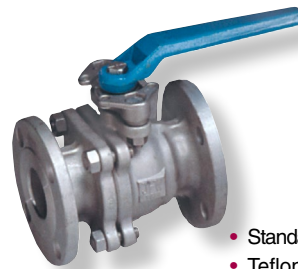

**316 (CF8M)
Stainless Steel
Flanged
Gate & Ball
Valves**

- Standard 150 lb. ANSI Flanges
- Teflon Internals
- 200 PSI Rating
- Full Port

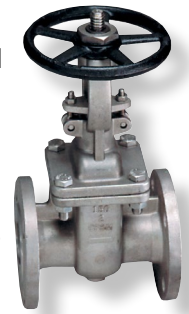

Part No.	Size	Type	NET EA.
KE BVF150-3	3"	Ball	\$ 761.00
KE GTF-4	4"	Gate	1371.00
KE GTF-6	6"	Gate	2498.00
KE GTF-8	8"	Gate	3874.00

316 Stainless Steel Ball Valves

Full Port • Teflon Seats
• Durable Large Stems

Rated to 1000 PSI W.O.G.

Part No.	FPT Ports	Flow Diameter	* NET EA.
GN 316-14	1/4"	1/4"	\$ 18.40
GN 316-38	3/8"	3/8"	18.40
GN 316-12	1/2"	1/2"	18.80
GN 316-34	3/4"	3/4"	25.50
GN 316-100	1"	1"	40.00
GN 316-114	1-1/4"	1-1/4"	56.00
GN 316-112	1-1/2"	1-1/2"	65.00
GN 316-200	2"	2"	100.00
GN 316-300	3"	3"	325.00

*** Quantity Discount
Less 10% on 10+
or Less 15% on 25+**

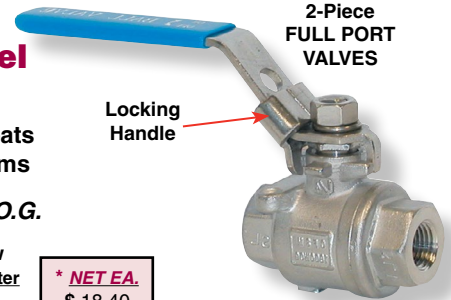

2-Piece FULL PORT VALVES

Locking Handle

Air Actuated Stainless Ball Valves

- 2-Piece -



Ball Valves Polypropylene

- Stainless Steel Bolts
- Viton® Seals
- 100% Teflon Seats



V150 Full Flow
V200 Std. Flow
V204FP Full Flow

V075 Full Flow
V100FP Full Flow
V125FP Full Flow



6-Bolt Valves
V200FP Full Flow
V300 Std. Flow
V300FP Full flow



VA150 Nozzle - 1-1/2"
VA200 Nozzle - 2"
VA200FP Nozzle - 2" Full Flow

Straight Mtg. Bracket
V25270 fits
V150 & V200
V10270 Fits
V100FP & V125

90° Mtg. Bracket
V25271 fits V150, V200
V10271 fits
V100FP & V125

Call for Current Pricing & Quantity Discounts!

LIQUID FERTILIZER CONTROLS & AUTOMATION SYSTEMS



Easy Automation, Inc. is an international supplier of automation technology to the agronomy, feed manufacturing, and grain handling industries. Founded in 1986, we have spent the last 35+ years creating innovative and practical solutions for agriculture industries.

24/7 UNATTENDED LOADOUT

24/7 unattended loadout allows trucks to pull up to a check-in kiosk, route to loadout, and start the blending process from an unattended touchscreen(s). After the load is complete, the truck can pull over a truck scale to capture a loaded weight, or receive load amount from a legal for trade mass meter, sign, and get a printed ticket. All while staying in the truck. Data is recorded and can be pulled for records.



CORE METER CONTROL PANEL

Meter control panel with core capabilities to run your fertilizer facility today, and the potential to build onto in the future. Pre-wired for easy installation, the core meter control panel is the perfect fit for a facility looking to automate their fertilizer meter system with the vision to potentially grow in the future.

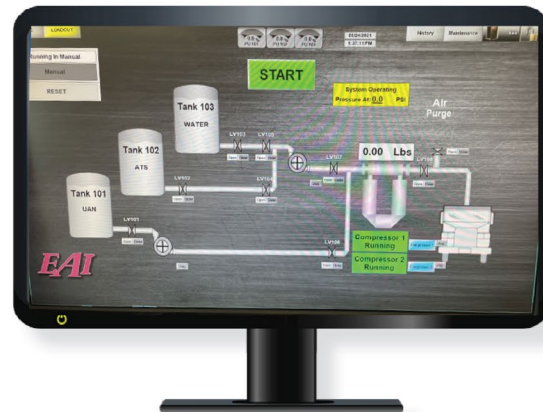

SHUTTLE FILL SYSTEM

The shuttle fill system is controlled by a custom HMI screen specific to your facility. The shuttle fill system is automated to utilize either a legal for trade meter or scale system. This system allows you to repackage bulk products into shuttles, kegs, or jugs for customer pick up or inventory stocking with ease and records.

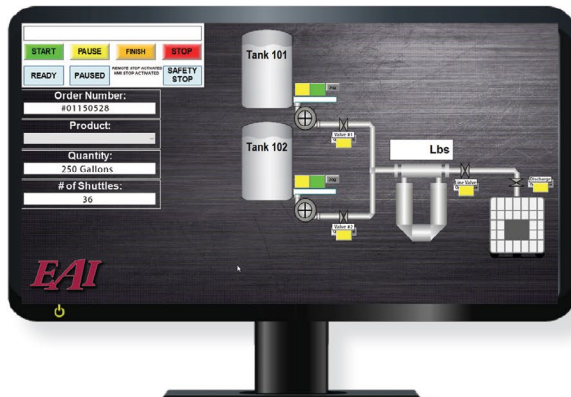

CHEMICAL WEIGH TANK

Chemical systems can be done with either meters or 250 gallon weigh tank designs. Whether you are looking for speed with a direct inject meter system or accuracy and flexibility with a weigh tank system, our customizable software and components can fit any chemical handling facility. The system can be run independently or paired with a fertilizer system to give you total control of your retail operations.





SUMMER 2024 NH3/EQUIPMENT SPECIALS

VISIT DULTMEIER.COM FOR NEW ITEMS AND MORE SPECIALS! GOOD THRU 9/13/24

Steel & Fiberglass Storage Tanks

FEATURES: (2) 3" FPT Couplings (One Siphon) may be threaded or flanged • 24" Bolted Manway • (4) Carbon Steel Combination Lift Eyes/Anchor Lugs • 3/4" Sight Tube, Stainless Fittings, Stainless "Deadman" Valve, S.S. Wind Guards • Exterior Pigmented (Colored) Tan or White.

Gallons	Diameter	Height
8,400	12'	10'
10,150	12'	12'
12,600	12'	15'
16,800	12'	20'
21,000	12'	25'
25,350	12'	30'
29,600	12'	35'

Call for Delivered Price



Stainless Steel, Cone & Transport Tanks Also Available

— Call Us for Details and Pricing —

Vertical & Cone Bottom Storage Tanks

10 to 20,000 Gallons Available

Ace Roto-Mold
SNYDER INDUSTRIES, INC.
NORWESCO

Standard & Heavy Duty Designs Available
Variety of Colors

Call for Pricing & Freight

Stainless Tank Inductor Systems 60 Gallon

60 Gallon Stainless Inductor Systems feature Banjo polyethylene flange fittings. Includes a water flush and jug rinse hose with 16" fill lid, 2" or 3" manifold system. Unit is plumbed with bypass loop for induction control.
Note: All units shipped assembled as shown.

1A60A-SS

Part No.	Stainless Tanks	Wt.
DU 1A60-SS	60 Gallon Inductor with Stainless Tank & 2" Manifold System.....	60 lbs.
DU 1A60A-SS	60 Gallon Inductor with Stainless Tank & 3" Manifold System.....	60 lbs.

Call For Current Pricing

Stainless Applicator & Nurse Tanks 430 to 1800 Gallon

Constructed of type 304 stainless steel, with #4 finish. These tanks are designed and constructed to withstand the rigors of open field use. Optional equipment, such as spargers, skids, ladders etc. are available to design a custom configuration. V Sumps provide best cleanout. Mounting kits included on 1600 gallon and smaller tanks. 16" manway with 10" quick fill flip lid. 1" stainless steel sight gauge fitting and lift lugs included. **Note:** DEF Storage requires backwelding - CALL.

Option Equipment for 430 to 540 Gallon Tanks:

- Box sump with 2" outlet • 48" V Sump with 2" outlet recommended
- Tank baffle • 1-1/2" Stainless sparger • 2" Stainless sparger pipe
- Mild steel banded skid • Mild steel weld-on skid • Stainless steel weld-on skid • Ladders

Option Equipment for 1000 to 1800 Gallon Tanks:

- Mild steel banded skid • Mild steel weld-on skid • Stainless steel weld-on skid • 36" V Sump with 3" outlet • 96" V Sump with 3" outlet • 1-1/2" Stainless sparger pipe • 2" Stainless sparger tube • Ladders & catwalks.



1,600 Gallon Tank Size Shown with Optional Skid



Call For Current Pricing

2000 to 4200 Gallon

Same Great Features As Noted Above!

Option Equipment for 2000 to 4200 Gallon Tanks:

- 3/16" Stainless steel weld-on skid
- 1/4" Mild steel weld-on skid • Box sump with 3" outlet • Box sump with 2" outlet • 36" V Sump with 3" outlet • 96" V Sump with 3" outlet • 144" V Sump with 3" outlet (recommended) • 2" Stainless sparger pipe • Mounting kits (spring style).

4,200 Gallon Tank Size Shown with Optional Ladder & SS Skid

Horizontal Elliptical Tanks

Ace Roto-Mold
FS3250-88 Shown On Optional Skid

Features: Free-standing elliptical tanks rated to 14 Lb./Gal. UV protected polyethylene construction with poly baffle and gallonage markers molded-in on one side and both ends. Black powder-coated steel support hoops and optional skids. Tanks have a 3" HD outlet fitting with siphon opposite an 18" lid.

TANKS - Less Hoops	Part No.	Gallon	Fillwell	Width	Height	Length	Outlet	Wt.	SPECIAL
	RT FS3250-88	3250	16"	88"	79"	146"	3"	1208 lbs.	\$ 5481.00
	RT FS3250-88-BLK	3250**	16"	88"	79"	146"	3"	1208 lbs.	5481.00

** Black Tank

Steel Hoops for Above Tanks (Required):

Part No.	Description	SPECIAL
RT FS3250-HP	1 Set of (4) 1-1/4" Steel Hoops with "feet" for FS3250-88 ...	\$ 1212.00

Steel Skid for Above Tanks (Optional):

Part No.	Description	Wt.	SPECIAL
RT FS23-32SK	Skid for FS2350 - 4250 Gallon Tanks, 90" x 146"	1078 lbs.	\$ 2723.00

Meter Calibration Jug

Features:

- Measurement vent tube
- Ensures precise liquid measurement regardless of foam presence
- Simplified clean out
- Quick emptying with reduced splashing
- Wide bottom for stability when filling

NEW

Part No.	Description	SPECIAL
DP CALJUG	3-5 gallon calibration jug for chemical meter	\$ 267.00



SUMMER 2024 NH3/EQUIPMENT SPECIALS

VISIT DULTMEIER.COM FOR NEW ITEMS AND MORE SPECIALS! GOOD THRU 9/13/24

Fuel Storage Tanks

Tanks Only or Complete Systems

Features:

- Three 2" top openings, 1-1/2" rotary gauge port & 2" drain
- Full-length skids
- Red enamel finish (White available)
- NOT UL listed



Part No.	Capacity	Size	Gauge	Wt.	SPECIAL
HS T520-50	520 Gallon	50" x 61"	14	350 lbs.	\$ 1443.00
HS T1000-64	1000 Gallon	64" x 72"	12	850 lbs.	2464.00

- Other Sizes & UL Listed Double Wall Tanks Available -

CIMTEK Fuel Filters

Cimtek Fuel Filters remove water and foreign material from fuel before it enters the tank. All-metal construction with spin-on FPT connections designed to handle gasolines and diesel fuels across a wide range of flow rates. Ideal for general purpose farm, construction, and mobile fueling applications, as well as high-volume fueling applications like truck stops, service stations, and commercial fueling systems. Hydrosorb elements have water filtration to completely remove water and impurities from fuel. Filter heads sold separately.



Part No.	Filter	Max Connection	Max GPM	Std. Pkg.	SPECIAL
CI 200E-30	30 Micron Element	3/4"	18	6	\$ 12.60
CI 260AHS10II	10M Hydrosorb Element	1"	18	12	20.10
CI 260AHS30II	30M Hydrosorb Element	1"	18	12	20.50
CI 300-30	30 Micron Element	3/4"	25	12	9.60
CI 400-30	30 Micron Element	1"	25	12	11.90
CI 800-30	30 Micron Element	1"	40	6	26.90
CI 800HS-10II	10M Hydrosorb Element	1"	40	6	34.40

10% Discount on Standard Pkgs. of Elements - Not Assorted

FILL-RITE Heavy-Duty Fuel Pumps

2 Year Warranty

12 Volt

Heavy Duty 12-Volt Fuel Pump with 12 ft. of hose, manual nozzle, suction pipe and 15 ft. power cables. 15 GPM. Less meter.

Part No.	Pump	SPECIAL
FR 1210		\$ 488.00
FR 807CMK	Meter Kit	267.00

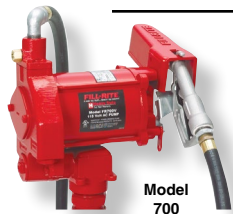

115 Volt

Heavy Duty 115-Volt Fuel Pump with 12 ft. of hose & manual nozzle. 20 GPM. Less meter.

Part No.	Pump, Less Meter	SPECIAL
FR FR700		\$ 784.00
FR FR701	Pump with Meter	964.00

Heavy Duty 115-Volt Fuel Pump with meter, 18 ft. of hose & automatic nozzle. 35 GPM.

Part No.	Pump, Less Meter	SPECIAL
FR 310VB		\$ 1609.00
FR FR311VB	Pump with Meter	1962.00

FILL-RITE Automatic Fuel Nozzles

UL/cUL Listed

Standard-Duty Fuel Nozzles with automatic shutoff. Rugged design for long-lasting performance during continued use. Color coding and differing spout diameters prevent cross fueling.



Part No.	Inlet	Style	Color	Spout	GPM	SPECIAL
FR SDN075R	3/4"	Unleaded	Red	13/16"	14.5	\$ 67.40
FR SDN075G	3/4"	Diesel	Green	15/16"	14.5	65.50
FR SDN100G	1"	Diesel	Green	1-1/8"	25	99.90

Piusi Portable DEF Tank Package

Standard Features:

- 58 or 116-Gallon Capacity
- SB325 DEF Automatic Nozzle
- 12V DC DEF Pump
- 13 Ft Discharge Hose
- 6.5 Ft Pump Power Cables with Clamps
- Lockable Lid
- Pallet Jack Base for Easy Loading or Unloading
- 9 GPM Pump
- 20 Min Duty Cycle
- Inlet is 2" BSP



Part No.	Description
PU PPT58	Portable DEF Tank Pkg, 58 Gal, 12V, 9GPM
PU PPT116	Portable DEF Tank Pkg, 116 Ga, 12V, 9GPM
PU F2066	12 Volt, 18 Ft. Power Cable Extension with Clamps.

Call for Pricing

Husky Husky EagleFlex®

Fuel Hose Assemblies



Ask About Quantity Discounts!

Part No.	Length	I.D.	Couplings	SPECIAL
GD L64-3/4X10	10'	3/4"	3/4" MPT	\$ 35.60
HK FT12S14	14'	3/4"	3/4" MPT	50.40
HK FT12S20	20'	3/4"	3/4" MPT	68.40
GD L64-1X10	10'	1"	1" MPT	51.90
GD L64-1x12	12'	1"	1" MPT	60.10
HK FT16S14	14'	1"	1" MPT	74.20
HK FT16S20	20'	1"	1" MPT	91.20

High Volume Diesel Transfer Pump Units



- Includes MP Petrolmaxx 2" x 2" Self-Priming Pump (Cast Iron with Viton® Seal)
- 6.5 HP Briggs or 5.7 HP CRX Engine, Manual or Electric Start
- 165 GPM @ 20 PSI (60 GPM thru 35' of 1-1/2" hose, 1-1/2" Double Filter & 1-1/2" Automatic Nozzle)

Part No.	Description	SPECIAL
DU MP25POB	2" CI Petrolmaxx Pump, 6.5 HP Briggs Engine, Manual Start	\$ 980.00
DU MP25PCRX	2" CI Petrolmaxx Pump, 5.7 HP CRX Engine, Manual Start	1038.00
DU MP25PCRXE	Same as Above with Electric Start	1185.00

Husky Automatic Farm Nozzles

The rugged trouble-free nozzle designed specifically for farm and consumer convenience.



5% Discount on 5+ One Size

Part No.	Inlet	1-GS Farm Nozzle	Color	Spout	GPM	SPECIAL
HK 45C	1" FPT	For Diesel Fuel	Green	15/16"	18	\$ 121.00
HK 45CU	1" FPT	For Unleaded Fuel	Red	13/16"	15	120.00
PU A120UL	1" FPT	Gas Diesel	Black			121.00
HK 45CHF	1" FPT	Gas Diesel	Green	1-1/8"	20	113.00



Box 45565

Omaha, Nebraska 68145-0565



Or Current Resident

PRSR STD
U.S. POSTAGE
PAID
OMAHA, NE
PERMIT NO. 314

NH3/LIQUID FERTILIZER PLANT EQUIPMENT

Special Prices Good Thru 9/13/24

VISIT DULTMEIER.COM FOR NEW ITEMS AND MORE SPECIALS!

OMAHA, NEBRASKA

13808 INDUSTRIAL ROAD
OMAHA, NE 68137

TOLL FREE 1.800.228.9666 LOCAL 1.402.333.1444 FAX NO. 1.402.333.5546
EMAIL DULTMEIER@DULTMEIER.COM

DAVENPORT, IOWA

601 WEST 76TH STREET
DAVENPORT, IA 52806

TOLL FREE 1.800.553.6975 LOCAL 1.563.386.0930 FAX NO. 1.563.386.5546
EMAIL DULTMEIER@DULTMEIER.COM

2024 NH3/PETROLEUM & DEF
EQUIPMENT INSIDE WITH
OUR FREE FREIGHT PROGRAM!

© DULTMEIER SALES 2024

Complete High Volume Diesel Transfer Pump Units



FPU1P

These rugged units are designed for high volume diesel transfer so you can fill equipment quickly and save valuable time. 1" Units will provide 32 GPM and 1-1/2" units will provide 60 GPM.

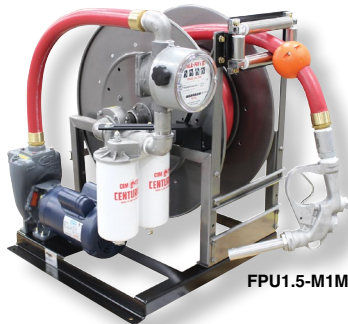

FPU1.5-M1M

Drive Options:

- Gas Engine
- Electric Motor
- Less Engine

Part No.	Description	Flowrate	Hose Size	SPECIAL
DU FPU1P	1" Diesel Transfer Unit	32 GPM	1"	\$ 3776.00
DU FPU1.5P	1-1/2" Diesel Transfer Unit	60 GPM	1-1/2"	5572.00
DU FPU1-M1	1" Diesel Unit, 3 HP Motor	32 GPM	1"	4665.00
DU FPU1.5-M1	1-1/2" Diesel Unit, 3 HP Motor	60 GPM	1-1/2"	6527.00
DU FPU1.5-M1M	1-1/2" Diesel Unit, 3 HP, with Meter	60 GPM	1-1/2"	7306.00



Large Hose Reels

For 2" & 3" Hose • Manual & 12V with Remote Controls

Super Reel™ Hose Reels are excellent for efficient and easy transfer of water and fertilizers through large 2" and 3" hoses. Great for farm, ranch, turf and other applications. All models include stainless steel swivels and non-corrosive top, bottom and side hose guide rollers. All 12-volt models include built-in hand switch and remote key fob for power in and power out reeling. *Not for use with fuels or oils.*



CHR1121
REMOTE

No FREE Freight

Part No.	Hose Size I.D.	Rewind	Ship Wt.	SPECIAL
FS HR200SS	2" & 2"	Manual	150 lbs	\$ 1430.00
FS HRE200SS	2" & 2"	12 Volt	150 lbs	1996.00
FS HRE300SS	3" & 3"	12 Volt	255 lbs.	3088.00
FS CHR1121	Additional Key Fob Remote Control....			40.30
DU 1AB2	2" Air Blowout Elbow Kit*			23.50
DU 1AB3	3" Air Blowout Elbow Kit*			75.70

* Each Kit includes (1) Poly Port Flange Elbow with 1/4" Gauge Port, (1) Flange by FPT Adapter, (1) Flange Clamp, (1) EPDM Gasket - for connection to hose reel inlet.

*FREIGHT EXCLUSIONS:

Exclusions apply. Dultmeier Sales' FREE FREIGHT PROGRAM is for supplies, repair parts and whole goods. Tanks, pipe, sprayers and other large equipment are not included in this program. Applies to Continental U.S. ground shipments only. Please call 1-888-677-5054 for details!